



Confirmat screw



Hole plug



Wood dowel

45° hinge

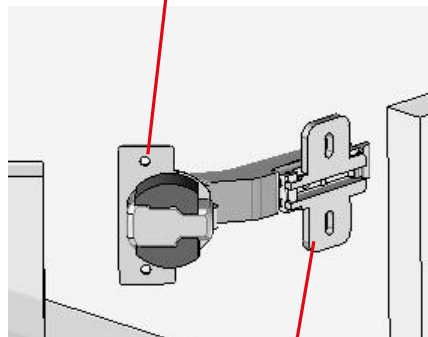

Hinge guide

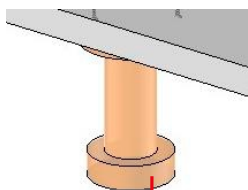

Kitchen furniture leg

1. Left side panel
2. Right side panel
3. Cabinet bottom panel
4. Left back wall
5. Right back wall
6. Left strip
7. Right strip
8. Cabinet top panel
9. Shelf
10. Door

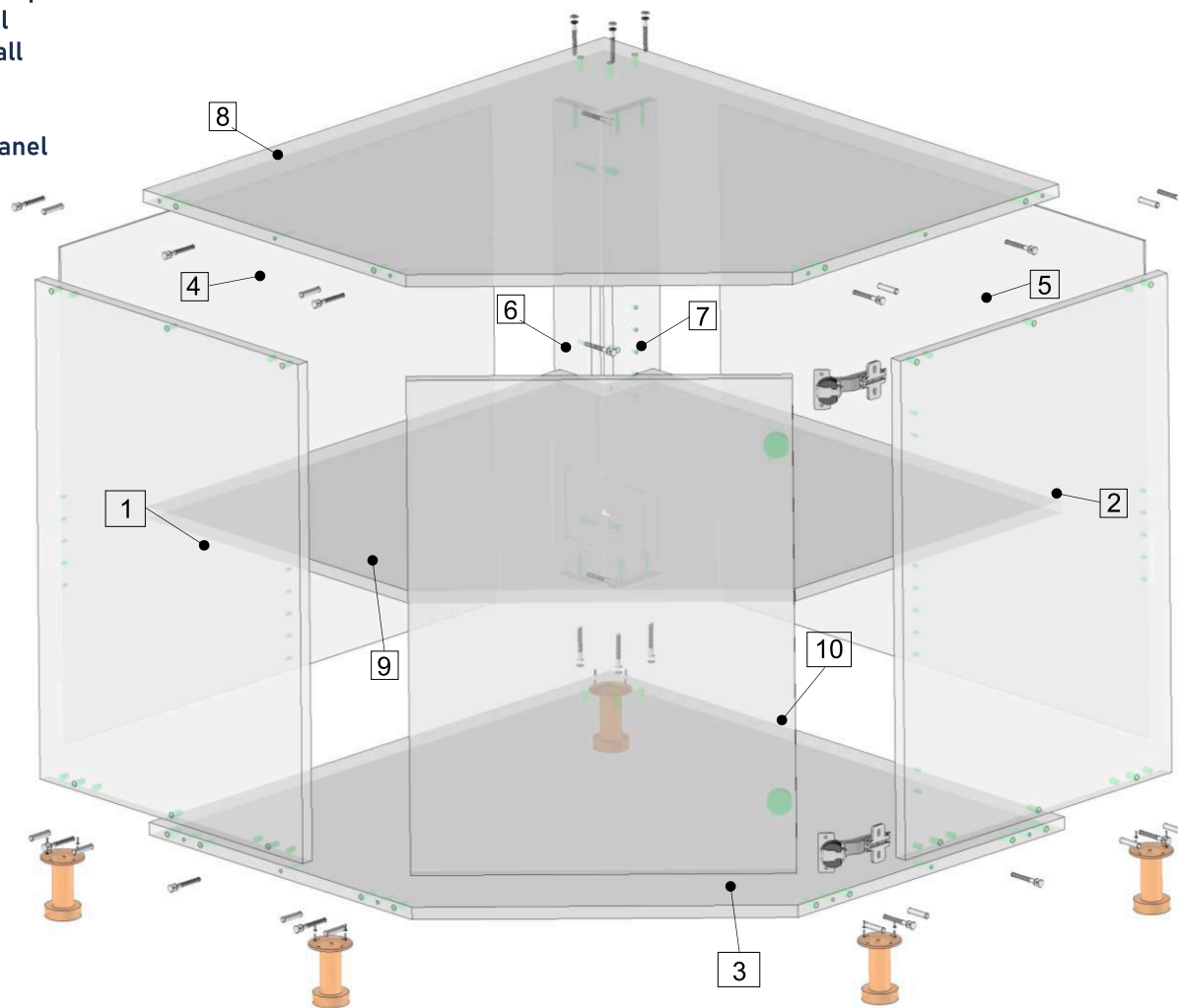



Fix the metal fitting on the furniture elements with the use of provided components. The assembly method of individual metal fitting is described in instruction manual „**Assembly of Accessories**”

Make sure that there are no shaving residues in the holes. Clear the holes if necessary.

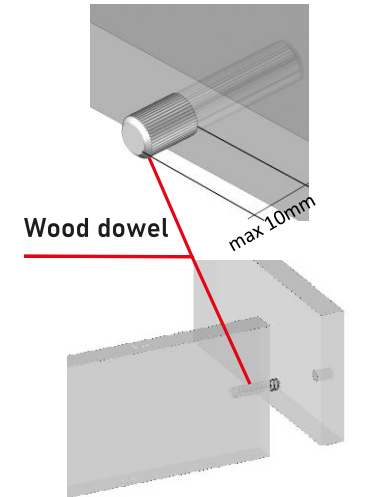
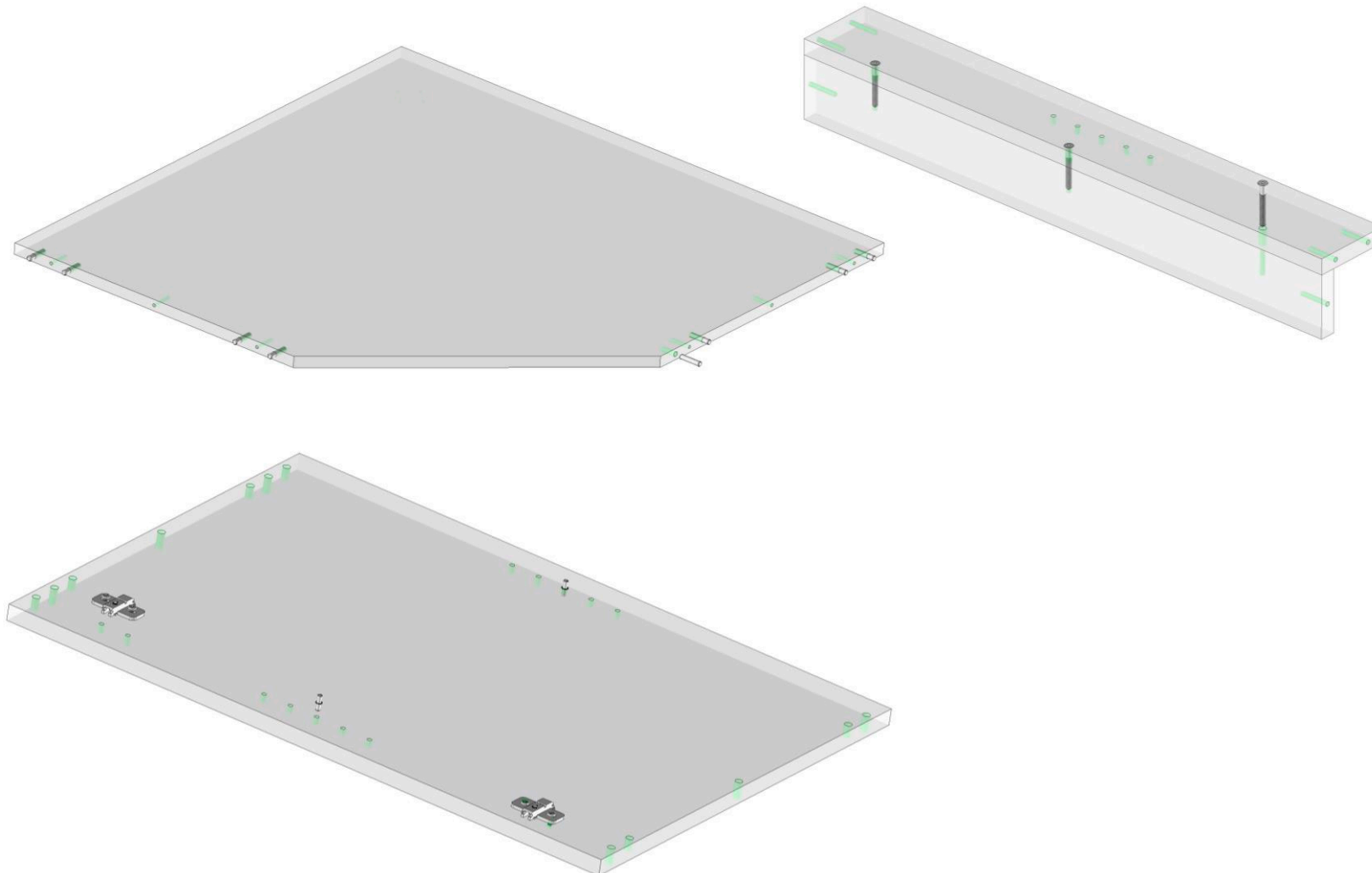

Confirmat screw

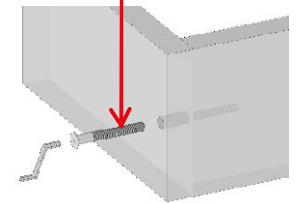

Shelf support

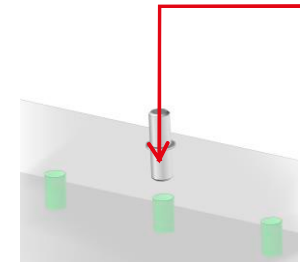



Join individual furniture elements together (the figure shows the version of the cabinet carcass with door on the right).

The recommended order of cabinet carcass assembly:

1. Screw together strips 6 and 7 with the use of confirmats.
2. Fix left side 1 to cabinet bottom panel 3 and top panel 8.
3. Fix right side 2 with cabinet bottom panel 3 and top panel 8.
4. Fix the screwed strips 6-7 to cabinet bottom panel 3 and top panel 8

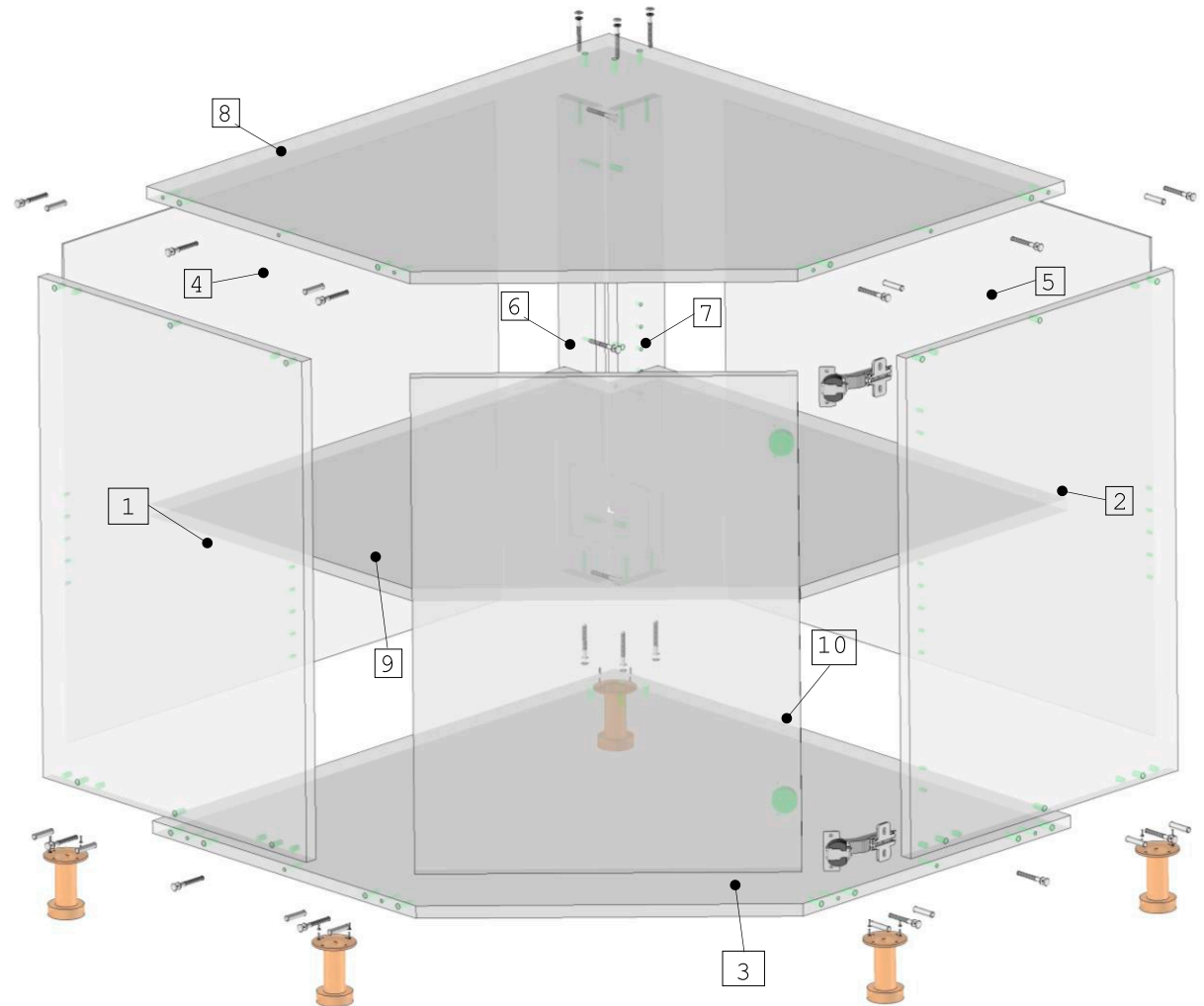
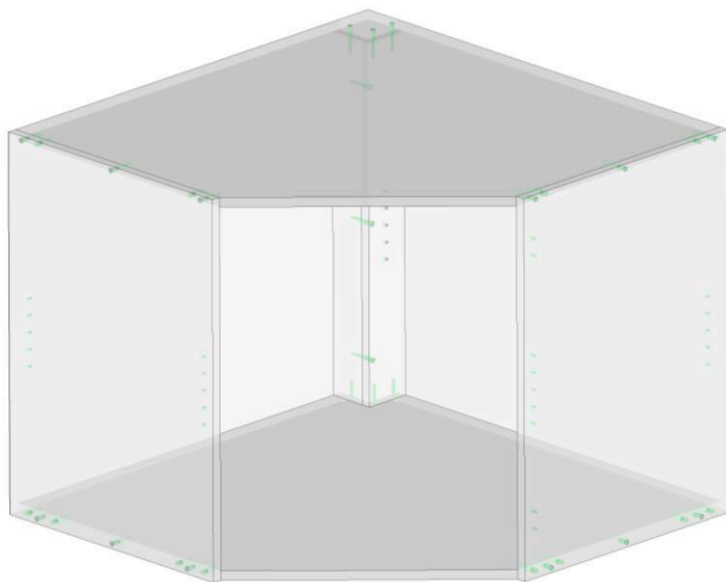



Set the rectangularity of the cabinet and assemble the back wall with the use of the nails provided (there are two back walls in the cabinet set).

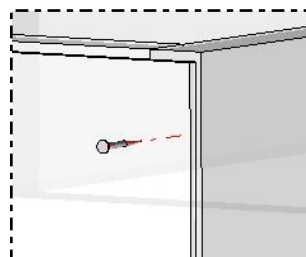
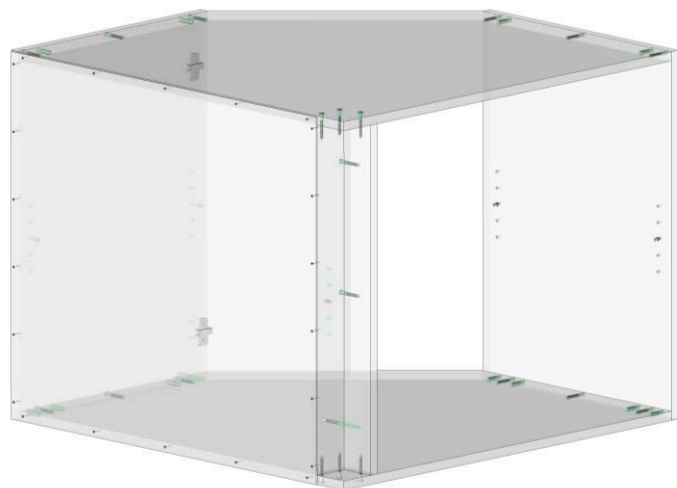

Attach the legs to the cabinet bottom panel using the provided screws.

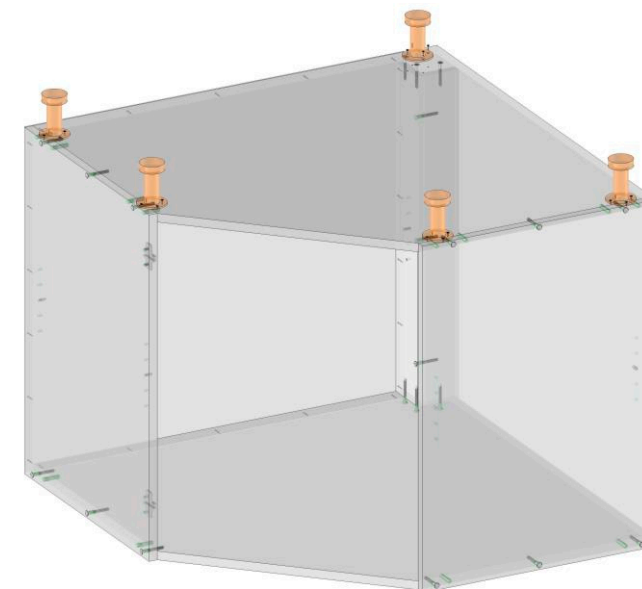

Slide the shelf inside the cabinet and assemble the second rear wall.

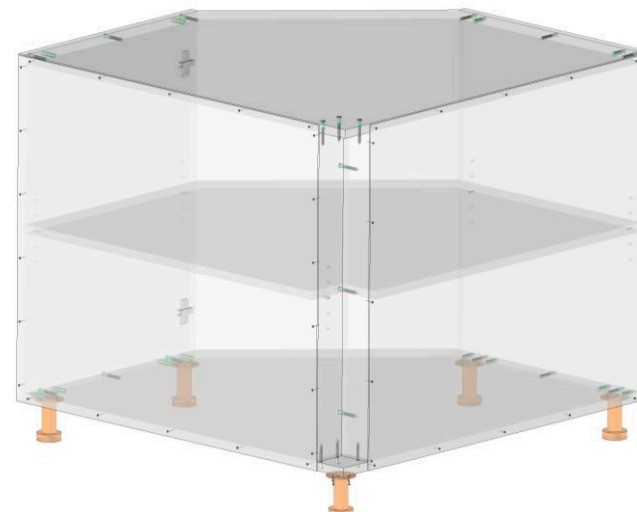
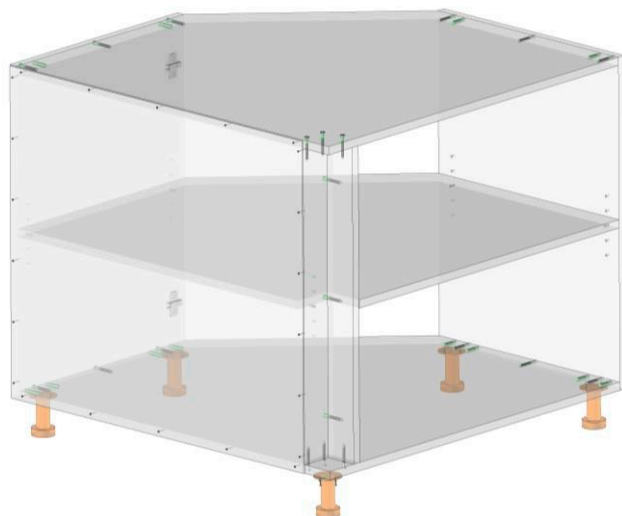



Screw the hinges and guides to the doors.

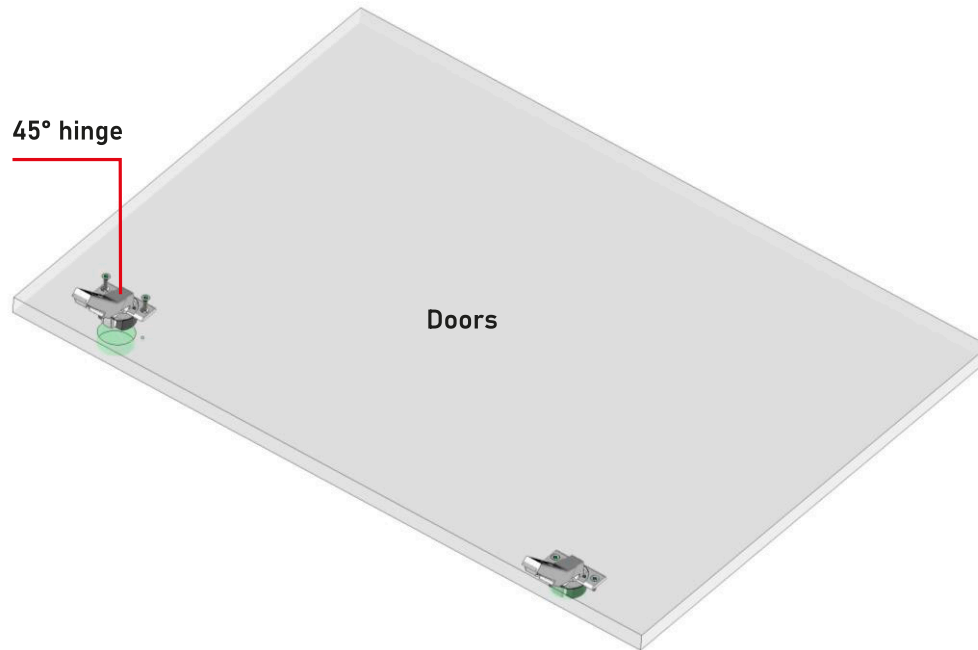

Depth adjustment

Side adjustment



Fix the door with metal fittings to the cabinet carcass. Adjust the position of doors (the adjustment of the depth, side and the gap between the doors can be performed on the hinges).

The vertical position of the doors can be adjusted on the guide (by loosening screws, setting the desired position of the doors, and tightening the screws again).

